



REPLACEMENT PARTS LIST

Packaged Terminal Air Conditioner

PTAC12H150A

Exploded View

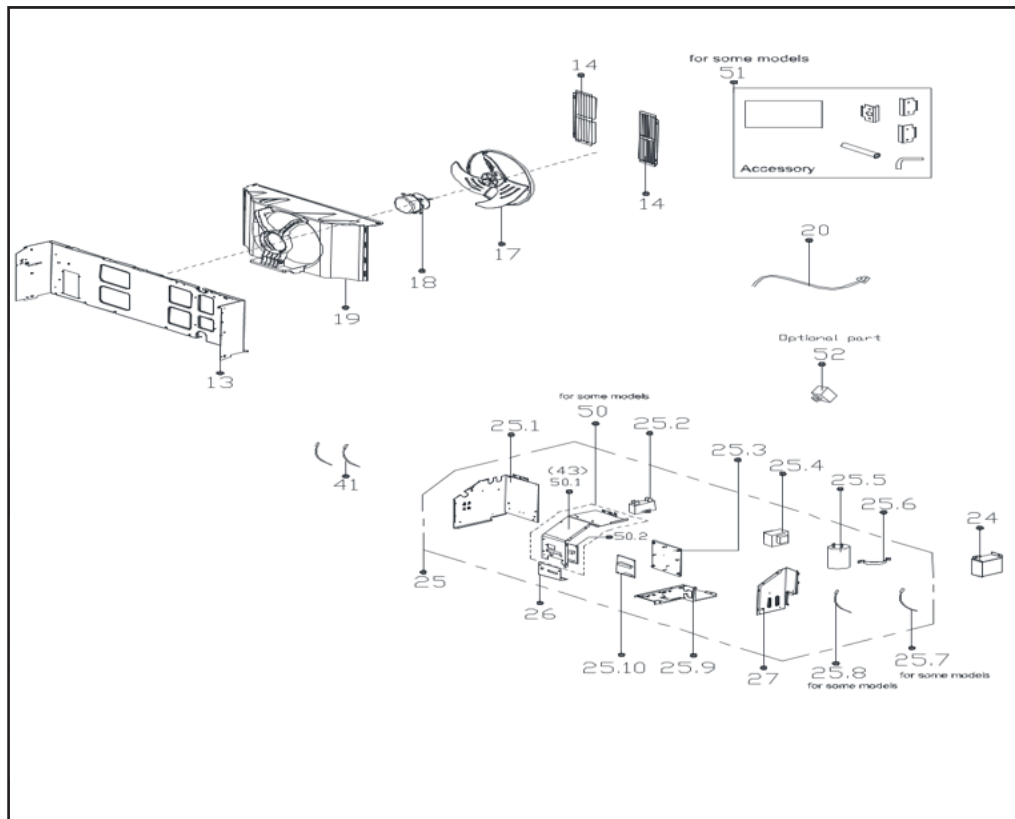
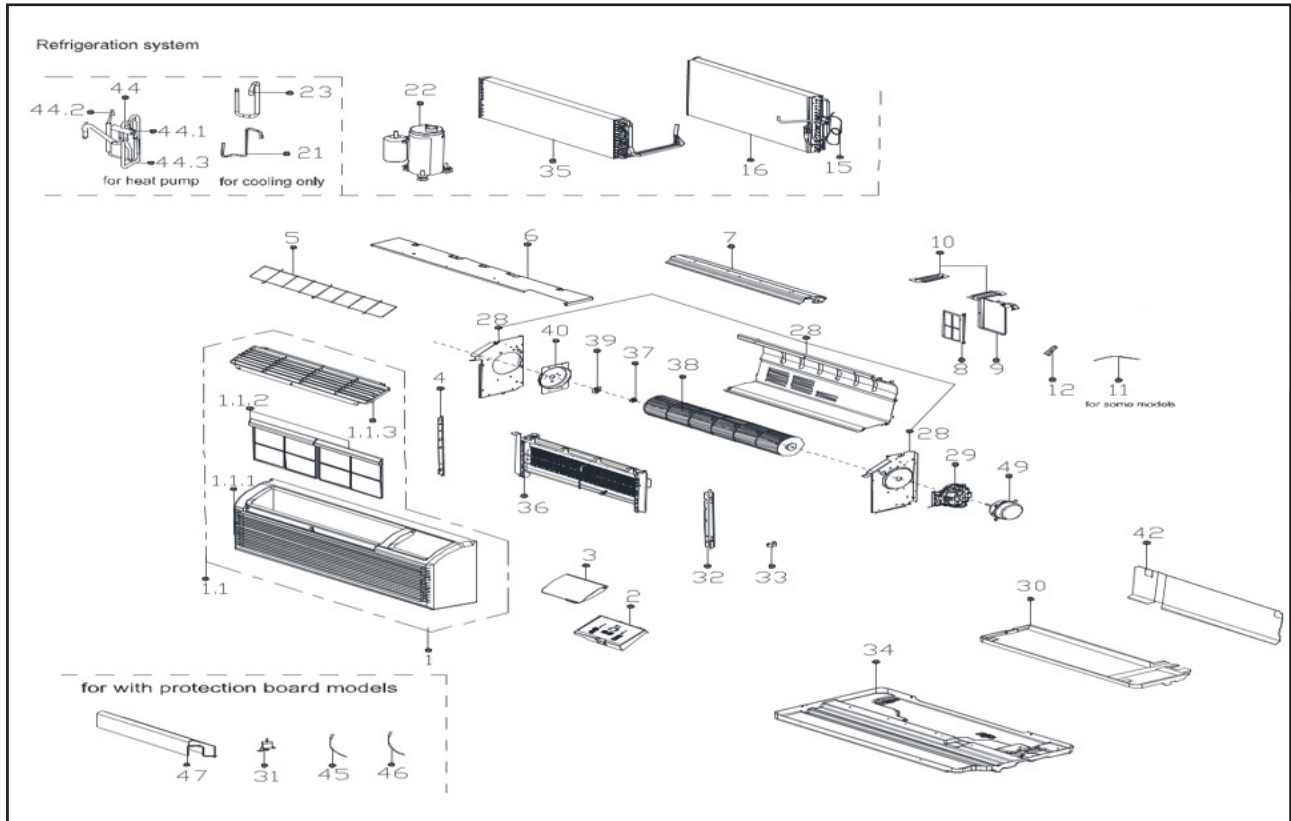

Replacement Parts List

Location	Description	Qty.	Part No.
1	Panel frame assembly	1.00	12120300007267
1.1	Panel frame subassembly	1.00	12120300000261
1.1.1	Panel frame	1.00	12120300003185
1.1.2	Filter	2.00	12120300A03940
1.1.3	Air outlet frame	1.00	12120300003184
2	Display Box Subassembly	1.00	17220300A25256
4	Fix board assembly	1.00	12220300005998
5	Rear net	1.00	12220300000533
6	Front cover assembly	1.00	12220300005439
7	Volute shell	1.00	12220300000518
9	Fresh Air Door Subassembly	1.00	12220300006978
10	Linker for front separating board	2.00	12220300000566
12	Connecting rod of fresh air door	1.00	12220300000312
13	Front separating board subassembly	1.00	12220300005438
14	Horizontal louver	2.00	12220300000517
15	Capillary assembly	1.00	15120300007557
16	Condenser assembly	1.00	15820300002962
17	Axial Flow Fan	1.00	12100105000064
18	Single Phase Asynchronous Motor	1.00	11002012033914
19	Rear separating	1.00	12120300000552
20	American standard power cord	1.00	17401202016222
21	Discharge pipe assembly	1.00	15120300007555
22	Fixed Speed Rotary Compressor	1.00	11103010021756
23	Suction pipe assembly	1.00	15120300007685
24	Line Board of Electrical Control Box	1.00	12220300000277
25	Electronic control box subassembly	1.00	17220300A24812
25.2	Fan Motor Capacitor	1.00	17400101A00484
25.3	Bracket of main control board	1.00	12120300007046
25.4	Linear Transformer	1.00	11203103000087
25.5	Compressor Capacitor	1.00	17400103000055
25.6	Capacitor clip	1.00	12200203000018
25.9	Base Plate of E-Parts Box	1.00	12220300000274
25.10	Main control board subassembly	1.00	17120300A06280
26	Dialing Cover of E-Parts Box	1.00	12220300A00131
27	Cover of electronic control box	1.00	12220300000303
28	Supporter subassembly of air passage	1.00	12220300005579
29	Motor cover assembly	1.00	12120300007064
30	Condenser water tray	1.00	12820300000028
31	Drain valve	1.00	17400510000003
32	Fix board assembly	1.00	12220300006018
33	Hook of Panel	2.00	12220300000560
34	Chassis assembly	1.00	12220300003658
35	Evaporator assembly	1.00	15820300003022
36	strip heater	1.00	17402004001599
37	Bearing Block	1.00	12622000000012
38	Cross Flow Fan	1.00	12100102000055
39	Cover of Bearing bracket	1.00	12220300000557

Replacement Parts List (continued)

40	Wind Baffle Board	1.00	12220300000514
41	Discharge Temperature Sensor	1.00	11201007003124
41	Discharge Temperature Sensor	1.00	11201007003427
42	Condenser Water Tray	1.00	12920300000002
45	Room Temperature Sensor	1.00	11201007003424
46	Pipe Temperature Sensor	1.00	11201007003447
47	Side plate	1.00	12220300000540
49	Brushless DC Motor	1.00	11002015018132
50	Dial switch subassembly	1.00	17122000A42290
50.1	Cover Of Electronic Control Box	1.00	12220300000272
50.2	Switchboard subassembly	1.00	17122000A42292
51	Accessory kit	1.00	12020300A00053

Page Intentionally Left Blank

Due to ongoing product improvements, specifications and dimensions are subject to change and correction without notice or incurring obligations. Determining the application and suitability for use of any product is the responsibility of the installer. Additionally, the installer is responsible for verifying dimensional data on the actual product prior to beginning any installation preparations.

Incentive and rebate programs have precise requirements as to product performance and certification. All products meet applicable regulations in effect on date of manufacture; however, certifications are not necessarily granted for the life of a product. Therefore, it is the responsibility of the applicant to determine whether a specific model qualifies for these incentive/rebate programs.



1900 Wellworth Ave., Jackson, MI 49203 • Ph. 517-787-2100 • www.marsdelivers.com

